

***Electromagnetic Emissions Test Report
and
Application for Grant of Equipment Authorization
pursuant to***

***Industry Canada RSS-Gen Issue 1 / RSS 210 Issue 6
FCC Part 15 Subpart C***

***on the
Meshdynamics
Transmitter
Model: MD4000***

UPN: 6935A-MD5
FCC ID: UZU-MD5

GRANTEE: Meshdynamics
2953 Bunker Hill Ln Suite 400
Santa Clara, CA 95054

TEST SITE: Elliott Laboratories, Inc.
684 W. Maude Ave
Sunnyvale, CA 94086

REPORT DATE: January 9, 2007

FINAL TEST DATE: September 13, September 25, October 18,
October 23, October 25 and October 27, 2006

AUTHORIZED SIGNATORY:

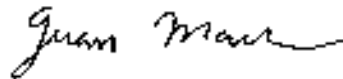

Juan Martinez
Senior EMC Engineer



2016-01

Elliott Laboratories, Inc. is accredited by the A2LA, certificate number 2016-01, to perform the test(s) listed in this report. This report shall not be reproduced, except in its entirety, without the written approval of Elliott Laboratories, Inc.

REVISION HISTORY

Revision #	Date	Comments	Modified By
1	March 26, 2007	Initial Release	David Guidotti
2	May 2, 2007	Changing Report to be a LMA so adding new FCC ID	Juan Martinez

TABLE OF CONTENTS

COVER PAGE..... 1

REVISION HISTORY..... 2

TABLE OF CONTENTS..... 3

SCOPE..... 5

OBJECTIVE..... 6

STATEMENT OF COMPLIANCE..... 7

TEST RESULTS SUMMARY 8

 DIGITAL TRANSMISSION SYSTEMS (5725 –5850 MHZ).....8

 GENERAL REQUIREMENTS APPLICABLE TO ALL BANDS.....9

MEASUREMENT UNCERTAINTIES 10

EQUIPMENT UNDER TEST (EUT) DETAILS 11

 GENERAL.....11

 ANTENNA SYSTEM11

 ENCLOSURE.....11

 MODIFICATIONS.....11

 SUPPORT EQUIPMENT.....12

 EUT INTERFACE PORTS.....12

 EUT OPERATION.....13

TEST SITE..... 14

 GENERAL INFORMATION.....14

 CONDUCTED EMISSIONS CONSIDERATIONS.....14

 RADIATED EMISSIONS CONSIDERATIONS.....14

MEASUREMENT INSTRUMENTATION..... 15

 RECEIVER SYSTEM.....15

 INSTRUMENT CONTROL COMPUTER.....15

 LINE IMPEDANCE STABILIZATION NETWORK (LISN).....15

 FILTERS/ATTENUATORS.....16

 ANTENNAS.....16

 ANTENNA MAST AND EQUIPMENT TURNTABLE.....16

 INSTRUMENT CALIBRATION.....16

TEST PROCEDURES 17

 EUT AND CABLE PLACEMENT.....17

 CONDUCTED EMISSIONS.....17

 RADIATED EMISSIONS.....17

 RADIATED EMISSIONS.....18

 BANDWIDTH MEASUREMENTS.....20

 SPECIFICATION LIMITS AND SAMPLE CALCULATIONS.....20

 GENERAL TRANSMITTER RADIATED EMISSIONS SPECIFICATION LIMITS.....21

 RECEIVER RADIATED SPURIOUS EMISSIONS SPECIFICATION LIMITS.....21

 OUTPUT POWER LIMITS – DIGITAL TRANSMISSION SYSTEMS.....22

 TRANSMIT MODE SPURIOUS RADIATED EMISSIONS LIMITS – FHSS AND DTS SYSTEMS.....22

 SAMPLE CALCULATIONS - CONDUCTED EMISSIONS.....23

 SAMPLE CALCULATIONS - RADIATED EMISSIONS.....23

 SAMPLE CALCULATIONS - FIELD STRENGTH TO EIRP CONVERSION.....24

TABLE OF CONTENTS (Continued)

EXHIBIT 1: Test Equipment Calibration Data..... 1
EXHIBIT 2: Test Measurement Data..... 2
EXHIBIT 3: Photographs of Test Configurations..... 3
EXHIBIT 4: Proposed FCC ID Label & Label Location 4
EXHIBIT 5: Detailed Photographs..... 5
EXHIBIT 6: Operator's Manual..... 6
EXHIBIT 7: Block Diagram..... 7
EXHIBIT 8: Schematic Diagrams..... 8
EXHIBIT 9: Theory of Operation..... 9
EXHIBIT 10: RF Exposure Information 10

SCOPE

An electromagnetic emissions test has been performed on the Meshdynamics model MD4000 pursuant to the following rules:

Industry Canada RSS-Gen Issue 1
RSS 210 Issue 6 “Low-power Licence-exempt Radiocommunication Devices (All Frequency Bands): Category I Equipment”
FCC Part 15 Subpart C

Conducted and radiated emissions data has been collected, reduced, and analyzed within this report in accordance with measurement guidelines set forth in the following reference standards and as outlined in Elliott Laboratories test procedures:

ANSI C63.4:2003
RSS-212 Issue 1 Test Facilities and Test Methods for Radio Equipment

The intentional radiator above has been tested in a simulated typical installation to demonstrate compliance with the relevant Industry Canada performance and procedural standards.

Final system data was gathered in a mode that tended to maximize emissions by varying orientation of EUT, orientation of power and I/O cabling, antenna search height, and antenna polarization.

Every practical effort was made to perform an impartial test using appropriate test equipment of known calibration. All pertinent factors have been applied to reach the determination of compliance.

The test results recorded herein are based on a single type test of the Meshdynamics model MD4000 and therefore apply only to the tested sample. The sample was selected and prepared by Sriram Dayanandan of Meshdynamics

OBJECTIVE

The primary objective of the manufacturer is compliance with the regulations outlined in the previous section.

Prior to marketing in the USA, all unlicensed transmitters and transceivers require certification. Receive-only devices operating between 30 MHz and 960 MHz are subject to either certification or a manufacturer's declaration of conformity, with all other receive-only devices exempt from the technical requirements.

Prior to marketing in Canada, Class I transmitters, receivers and transceivers require certification. Class II devices are required to meet the appropriate technical requirements but are exempt from certification requirements.

Certification is a procedure where the manufacturer submits test data and technical information to a certification body and receives a certificate or grant of equipment authorization upon successful completion of the certification body's review of the submitted documents. Once the equipment authorization has been obtained, the label indicating compliance must be attached to all identical units, which are subsequently manufactured.

Maintenance of compliance is the responsibility of the manufacturer. Any modification of the product which may result in increased emissions should be checked to ensure compliance has been maintained (i.e., printed circuit board layout changes, different line filter, different power supply, harnessing or I/O cable changes, etc.).

STATEMENT OF COMPLIANCE

The tested sample of Meshdynamics model MD4000 complied with the requirements of the following regulations:

Industry Canada RSS-Gen Issue 1
RSS 210 Issue 6 “Low-power Licence-exempt Radiocommunication Devices (All Frequency Bands): Category I Equipment”
FCC Part 15 Subpart C

Maintenance of compliance is the responsibility of the manufacturer. Any modification of the product which may result in increased emissions should be checked to ensure compliance has been maintained (i.e., printed circuit board layout changes, different line filter, different power supply, harnessing or I/O cable changes, etc.).

TEST RESULTS SUMMARY**DIGITAL TRANSMISSION SYSTEMS (5725 –5850 MHz)**

FCC Rule Part	RSS Rule Part	Description	Measured Value / Comments	Limit / Requirement	Result
15.247(a)	RSS 210 A8.2	Digital Modulation	Systems uses OFDM techniques	System must utilize a digital transmission technology	Complies
15.247 (a) (2)	RSS 210 A8.2 (1)	6dB Bandwidth	16.5 MHz	>500kHz	Complies
	RSP100	99% Bandwidth	17.1 MHz	Information only	Complies
15.247 (b) (3) 15.247		Output Power (multipoint systems)	19.25 dBm (.084 Watts) EIRP = 0.093 W ^{Note 1}	1Watt, EIRP limited to 4 Watts.	Complies
15.247(d)	RSS 210 A8.2 (2)	Power Spectral Density	-2.4dBm / kHz	Maximum permitted is 8dBm/3kHz	Complies
15.247(c)	RSS 210 A8.5	Antenna Port Spurious Emissions – 30MHz – 40 GHz	All spurious emissions < -20dBc	< -30dBc ^{Note 2}	Complies
15.247(c) / 15.209	RSS 210 A8.5 Table 2, 3	Radiated Spurious Emissions 30MHz – 40 GHz	52.0dBμV/m (398.1μV/m) @ 11568.7MHz (-2.0dB)	15.207 in restricted bands, all others < -30dBc ^{Note 2}	Complies

Note 1: EIRP calculated using antenna gain of 8 dBi for the highest EIRP multi-point system.

Note 2: Limit of -30dBc used because the power was measured using the UNII test procedure (maximum power averaged over a transmission burst).

GENERAL REQUIREMENTS APPLICABLE TO ALL BANDS

FCC Rule Part	RSS Rule part	Description	Measured Value / Comments	Limit / Requirement	Result (margin)
15.203	-	RF Connector	N-Type device is professionally installed		Complies
15.109	RSS GEN 7.2.3 Table 1	Receiver spurious emissions	47.1dB μ V/m (225.9 μ V/m) @ 7053.4MHz		Complies (- 6.9 dB)
15.207	RSS GEN Table 2	AC Conducted Emissions	N/A – EUT is DC operated	Refer to standard	Complies
15.247 (b) (5) 15.407 (f)	RSS 102	RF Exposure Requirements	Refer to MPE calculations in Exhibit 11, RSS 102 declaration and User Manual statements.	Refer to OET 65, FCC Part 1 and RSS 102	Complies
	RSP 100 RSS GEN 7.1.5	User Manual		Statement required regarding detachable antenna	

MEASUREMENT UNCERTAINTIES

ISO Guide 17025 requires that an estimate of the measurement uncertainties associated with the emissions test results be included in the report. The measurement uncertainties given below are based on a 95% confidence level and were calculated in accordance with UKAS document LAB 34.

Measurement Type	Frequency Range (MHz)	Calculated Uncertainty (dB)
Conducted Emissions	0.15 to 30	± 2.4
Radiated Emissions	0.015 to 30	± 3.0
Radiated Emissions	30 to 1000	± 3.6
Radiated Emissions	1000 to 40000	± 6.0

EQUIPMENT UNDER TEST (EUT) DETAILS**GENERAL**

The Meshdynamics model MD4000 is a Mesh Router which is designed to wirelessly route client data into the network. Normally, the EUT would be placed on a table top during operation. The EUT was, therefore, treated as table-top equipment during testing to simulate the end-user environment. The electrical rating of the EUT is 120/240 V, 50/60 Hz, 7.5 Amps.

The sample was received on September 13, 2006 and tested on September 13, September 25, October 18, October 23, October 25 and October 27, 2006. The EUT consisted of the following component(s):

Manufacturer	Model	Description	Serial Number
Meshdynamics	MD4350-AA-G	Mesh Router	14456
Meshdynamics	MD5	5Ghz Module	-

ANTENNA SYSTEM

The EUT antenna has one 8dBi antenna for both 2.4 and 5Ghz.

The external antenna will be professionally installed.

The antennas connect to the EUT via a standard N Female, thereby professional installation will be required.

ENCLOSURE

The EUT enclosure is primarily constructed of fabricated sheet steel. It measures approximately 20 cm wide by 15 cm deep by 5 cm high.

MODIFICATIONS

The EUT did not require modifications during testing in order to comply with emissions specifications.

SUPPORT EQUIPMENT

The following equipment was used as local support equipment for emissions testing:

Config 1

Manufacturer	Model	Description	Serial Number
Meshdynamics	MD4350-AA-G	Mesh Router	14446
	POE - 12i	Injector of Power over Ethernet	181
Airlink	AR504	4 port Switch Router	3EE04B01314
Dell	C840	PC Laptop	3J578 AJ1
Sony	PCG-883L	PC Laptop	n/a

Config 2

Manufacturer	Model	Description	Serial Number	FCC ID
Unknown	POE - 24i	Power over Ethernet Injector	0560145	DoC
Unknown	EZ500-S	GigaFast Ethernet Hub	1338002375	DoC
Unknown	MW41- 0751000	AC/DC Adaptor for Hub	-	-
Dell	Inspiron 600m	Laptop Computer	Service Tag 90ZXC91	DoC
Dell	PA-1650-05D2	AC Adapter for Laptop	CN-0F7970- 71615-5CD- 225C	-

No remote support equipment was used during emissions testing.

EUT INTERFACE PORTS

The I/O cabling configuration during emissions testing was as follows:

Config 1

Port	Connected To	Cable(s)		
		Description	Shielded or Unshielded	Length(m)
POE	Injector	Cat. 5 Ethernet	unshielded cat 5	10

Config 2

Port	Connected To	Cable(s)		
		Description	Shielded or Unshielded	Length(m)
EUT Connections				
RF Port Under Test	Antenna	Direct Connection	-	-
Other RF Ports	Unterminated	-	-	-
Ethernet Port #1	POE Injector	Cat5 UTP	Unshielded	1.0
Ethernet Port #2 (Bridge Port)	Not Cabled	-	-	-
Serial Port	Dell Laptop	Ribbon Cable to Serial RS-232	Unshielded and Shielded	1.0
Additional Connections				
Dell Laptop, DC Input	External AC Adapter	DC Power Leads	Unshielded	1.0
Dell External AC Adapter	120V/60Hz	AC Power Cord	Unshielded	1.0
Hub, DC Input	External AC Adapter	DC Power Leads	Unshielded	1.0
POE Injector, AC Input	120V/60Hz	AC Power Cord	Unshielded	1.0

Note: The Bridge port were not connected as the manufacturer stated that these are for peripheral devices purpose and therefore would not normally be connected.

Note 1: No Ethernet connection on the Injector of Power over Ethernet makes it Repeater mode.

EUT OPERATION

During emissions testing, the EUT was in Transmit or Receive Mode as noted in the test data.

TEST SITE

GENERAL INFORMATION

Final test measurements were taken on September 13, September 25, October 18, October 23, October 25 and October 27, 2006 at the Elliott Laboratories Open Area Test Site #1 (FCC registration number: 90593) located at 684 West Maude Avenue, Sunnyvale, California. Pursuant to section 2.948 of the FCC's Rules and section 3.3 of RSP-100, construction, calibration, and equipment data has been filed with the Commission.

ANSI C63.4:2003 recommends that ambient noise at the test site be at least 6 dB below the allowable limits. Ambient levels are below this requirement with the exception of predictable local TV, radio, and mobile communications traffic. The test site contains separate areas for radiated and conducted emissions testing. Considerable engineering effort has been expended to ensure that the facilities conform to all pertinent requirements of ANSI C63.4:2003 and RSS 212.

CONDUCTED EMISSIONS CONSIDERATIONS

Conducted emissions testing is performed in conformance with ANSI C63.4:2003 and RSS 212. Measurements are made with the EUT connected to the public power network through a nominal, standardized RF impedance, which is provided by a line impedance stabilization network, known as a LISN. A LISN is inserted in series with each current-carrying conductor in the EUT power cord.

RADIATED EMISSIONS CONSIDERATIONS

The FCC has determined that radiation measurements made in a shielded enclosure are not suitable for determining levels of radiated emissions. Radiated measurements are performed in an open field environment or in a semi-anechoic chamber. The test sites are maintained free of conductive objects within the CISPR defined elliptical area incorporated in ANSI C63.4:2003 guidelines and meet the Normalized Site Attenuation (NSA) requirements of ANSI C63.4:2003 / RSS 212.

MEASUREMENT INSTRUMENTATION

RECEIVER SYSTEM

An EMI receiver as specified in CISPR 16-1 is used for emissions measurements. The receivers used can measure over the frequency range of 9 kHz up to 2000 MHz. These receivers allow both ease of measurement and high accuracy to be achieved. The receivers have Peak, Average, and CISPR (Quasi-peak) detectors built into their design so no external adapters are necessary. The receiver automatically sets the required bandwidth for the CISPR detector used during measurements. If the repetition frequency of the signal being measured is below 20Hz, peak measurements are made in lieu of Quasi-Peak measurements.

For measurements above the frequency range of the receivers, a spectrum analyzer is utilized because it provides visibility of the entire spectrum along with the precision and versatility required to support engineering analysis. Average measurements above 1000MHz are performed on the spectrum analyzer using the linear-average method with a resolution bandwidth of 1 MHz and a video bandwidth of 10 Hz, unless the signal is pulsed in which case the average (or video) bandwidth of the measuring instrument is reduced to onset of pulse desensitization and then increased.

INSTRUMENT CONTROL COMPUTER

The receivers utilize either a Rohde & Schwarz EZM Spectrum Monitor/Controller or contain an internal Spectrum Monitor/Controller to view and convert the receiver measurements to the field strength at an antenna or voltage developed at the LISN measurement port, which is then compared directly with the appropriate specification limit. This provides faster, more accurate readings by performing the conversions described under Sample Calculations within the Test Procedures section of this report. Results are printed in a graphic and/or tabular format, as appropriate. A personal computer is used to record all measurements made with the receivers.

The Spectrum Monitor provides a visual display of the signal being measured. In addition, the controller or a personal computer run automated data collection programs which control the receivers. This provides added accuracy since all site correction factors, such as cable loss and antenna factors are added automatically.

LINE IMPEDANCE STABILIZATION NETWORK (LISN)

Line conducted measurements utilize a fifty microhenry Line Impedance Stabilization Network as the monitoring point. The LISN used also contains a 250 uH CISPR adapter. This network provides for calibrated radio frequency noise measurements by the design of the internal low pass and high pass filters on the EUT and measurement ports, respectively.

FILTERS/ATTENUATORS

External filters and precision attenuators are often connected between the receiving antenna or LISN and the receiver. This eliminates saturation effects and non-linear operation due to high amplitude transient events.

ANTENNAS

A loop antenna is used below 30 MHz. For the measurement range 30 MHz to 1000 MHz either a combination of a biconical antenna and a log periodic or a bi-log antenna is used. Above 1000 MHz, horn antennas are used. The antenna calibration factors to convert the received voltage to an electric field strength are included with appropriate cable loss and amplifier gain factors to determine an overall site factor, which is then programmed into the test receivers or incorporated into the test software.

ANTENNA MAST AND EQUIPMENT TURNTABLE

The antennas used to measure the radiated electric field strength are mounted on a non-conductive antenna mast equipped with a motor-drive to vary the antenna height. Measurements below 30 MHz are made with the loop antenna at a fixed height of 1m above the ground plane.

ANSI C63.4:2003 and RSS 212 specify that the test height above ground for table mounted devices shall be 80 centimeters. Floor mounted equipment shall be placed on the ground plane if the device is normally used on a conductive floor or separated from the ground plane by insulating material from 3 to 12 mm if the device is normally used on a non-conductive floor. During radiated measurements, the EUT is positioned on a motorized turntable in conformance with this requirement.

INSTRUMENT CALIBRATION

All test equipment is regularly checked to ensure that performance is maintained in accordance with the manufacturer's specifications. All antennas are calibrated at regular intervals with respect to tuned half-wave dipoles. An exhibit of this report contains the list of test equipment used and calibration information.

TEST PROCEDURES

EUT AND CABLE PLACEMENT

The regulations require that interconnecting cables be connected to the available ports of the unit and that the placement of the unit and the attached cables simulate the worst case orientation that can be expected from a typical installation, so far as practicable. To this end, the position of the unit and associated cabling is varied within the guidelines of ANSI C63.4:2003, and the worst-case orientation is used for final measurements.

CONDUCTED EMISSIONS

Conducted emissions are measured at the plug end of the power cord supplied with the EUT. Excess power cord length is wrapped in a bundle between 30 and 40 centimeters in length near the center of the cord. Preliminary measurements are made to determine the highest amplitude emission relative to the specification limit for all the modes of operation. Placement of system components and varying of cable positions are performed in each mode. A final peak mode scan is then performed in the position and mode for which the highest emission was noted on all current carrying conductors of the power cord.

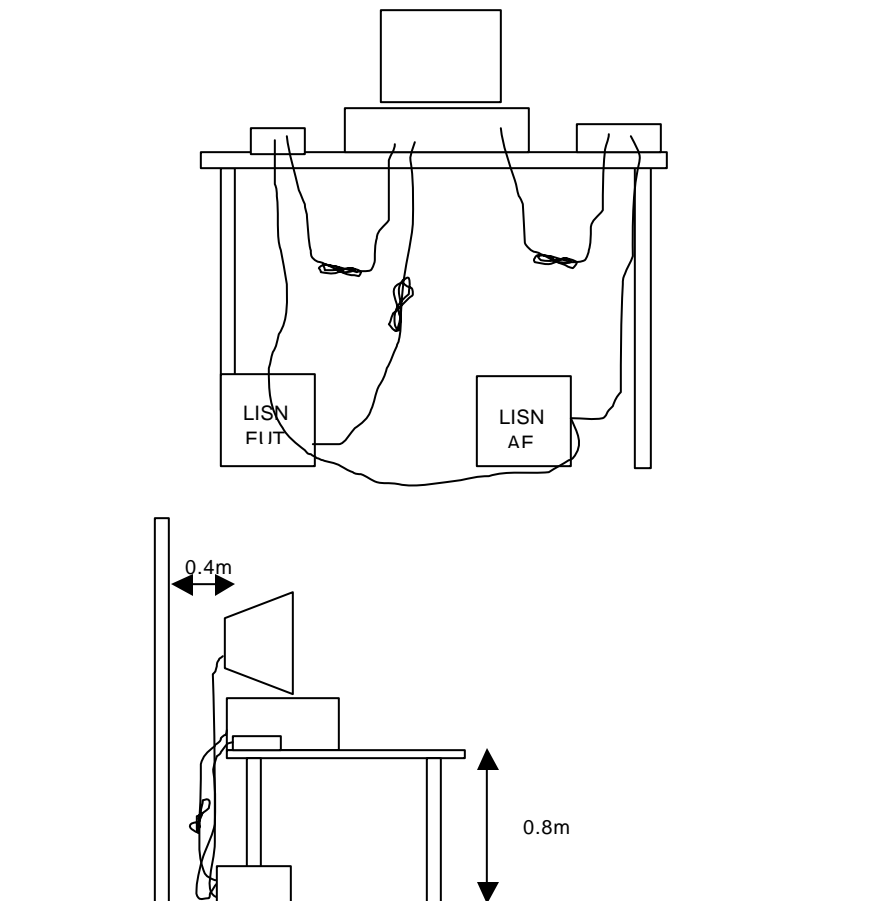

RADIATED EMISSIONS

A preliminary scan of the radiated emissions is performed in which all significant EUT frequencies are identified with the system in a nominal configuration. At least two scans are performed, one scan for each antenna polarization (horizontal and vertical; loop parallel and perpendicular to the EUT). During the preliminary scans, the EUT is rotated through 360°, the antenna height is varied (for measurements above 30 MHz) and cable positions are varied to determine the highest emission relative to the limit. Preliminary scans may be performed in a fully anechoic chamber for the purposes of identifying the frequencies of the highest emissions from the EUT.

A speaker is provided in the receiver to aid in discriminating between EUT and ambient emissions. Other methods used during the preliminary scan for EUT emissions involve scanning with near field magnetic loops, monitoring I/O cables with RF current clamps, and cycling power to the EUT.

Final maximization is a phase in which the highest amplitude emissions identified in the spectral search are viewed while the EUT azimuth angle is varied from 0 to 360 degrees relative to the receiving antenna. The azimuth, which results in the highest emission is then maintained while varying the antenna height from one to four meters (for measurements above 30 MHz, measurements below 30 MHz are made with the loop antenna at a fixed height of 1m). The result is the identification of the highest amplitude for each of the highest peaks. Each recorded level is corrected in the receiver using appropriate factors for cables, connectors, antennas, and preamplifier gain.

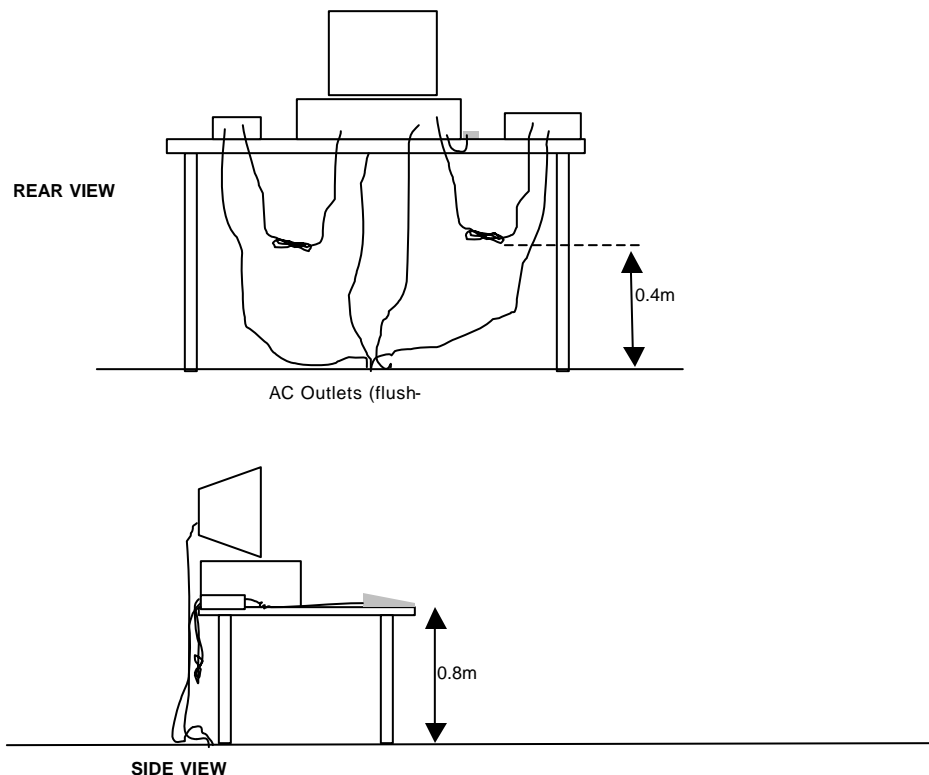

Typical Test Configuration for Radiated Field Strength Measurements

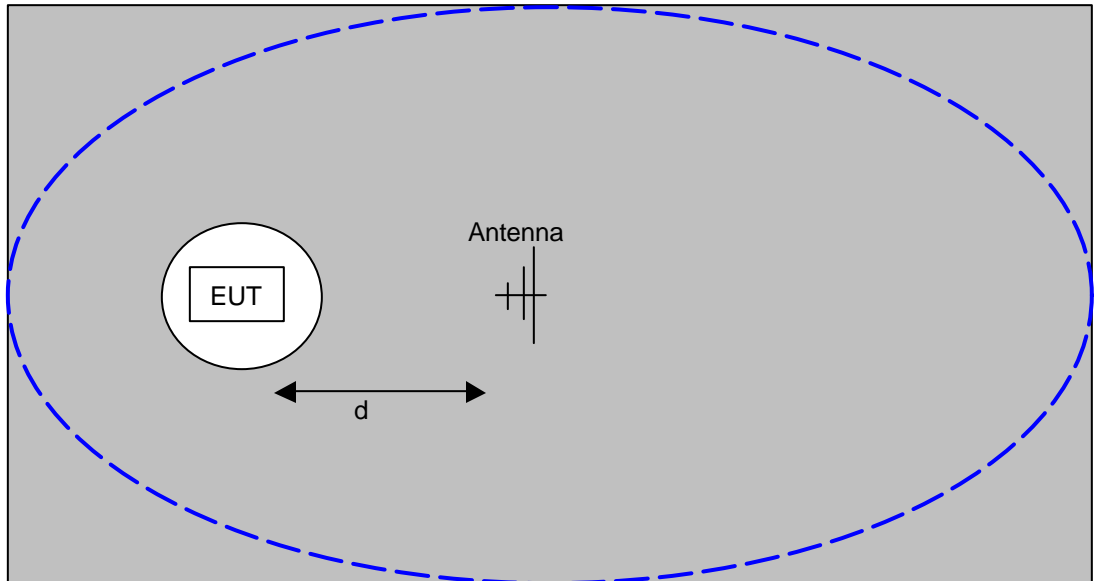

The ground plane extends beyond the ellipse defined in CISPR 16 / CISPR 22 / ANSI C63.4 and is large enough to accommodate test distances (d) of 3m and 10m. Refer to the test data tables for the actual measurement distance.

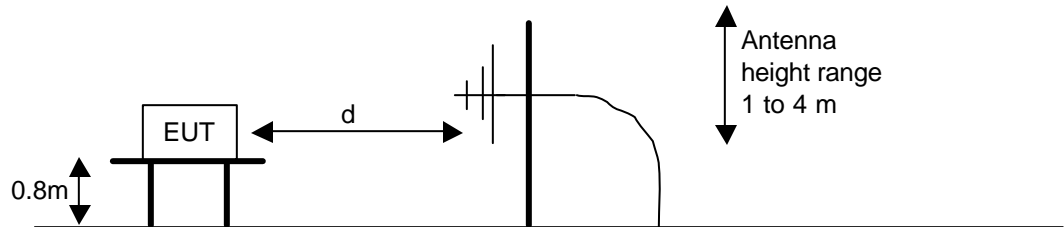

Test Configuration for Radiated Field Strength Measurements
OATS- Plan and Side Views

BANDWIDTH MEASUREMENTS

The 6dB, 20dB and/or 26dB signal bandwidth is measured in using the bandwidths recommended by ANSI C63.4. When required, the 99% bandwidth is measured using the methods detailed in RSS GEN.

SPECIFICATION LIMITS AND SAMPLE CALCULATIONS

The limits for conducted emissions are given in units of microvolts, and the limits for radiated emissions are given in units of microvolts per meter at a specified test distance. Data is measured in the logarithmic form of decibels relative to one microvolt, or dB microvolts (dBuV). For radiated emissions, the measured data is converted to the field strength at the antenna in dB microvolts per meter (dBuV/m). The results are then converted to the linear forms of uV and uV/m for comparison to published specifications.

For reference, converting the specification limits from linear to decibel form is accomplished by taking the base ten logarithm, then multiplying by 20. These limits in both linear and logarithmic form are as follows:

GENERAL TRANSMITTER RADIATED EMISSIONS SPECIFICATION LIMITS

The table below shows the limits for the spurious emissions from transmitters that fall in restricted bands¹ (with the exception of transmitters operating under FCC Part 15 Subpart D and RSS 210 Annex 9), the limits for all emissions from a low power device operating under the general rules of RSS 310 (tables 3 and 4), RSS 210 (table 2) and FCC Part 15 Subpart C section 15.209.

Frequency Range (MHz)	Limit (uV/m)	Limit (dBuV/m @ 3m)
0.009-0.490	$2400/F_{\text{KHz}} @ 300\text{m}$	$67.6-20*\log_{10}(F_{\text{KHz}}) @ 300\text{m}$
0.490-1.705	$24000/F_{\text{KHz}} @ 30\text{m}$	$87.6-20*\log_{10}(F_{\text{KHz}}) @ 30\text{m}$
1.705 to 30	30 @ 30m	29.5 @ 30m
30 to 88	100 @ 3m	40 @ 3m
88 to 216	150 @ 3m	43.5 @ 3m
216 to 960	200 @ 3m	46.0 @ 3m
Above 960	500 @ 3m	54.0 @ 3m

RECEIVER RADIATED SPURIOUS EMISSIONS SPECIFICATION LIMITS

The table below shows the limits for the spurious emissions from receivers as detailed in FCC Part 15.109, RSS 210 Table 2, RSS GEN Table 1 and RSS 310 Table 3. Note that receivers operating outside of the frequency range 30 MHz – 960 MHz are exempt from the requirements of 15.109.

Frequency Range (MHz)	Limit (uV/m @ 3m)	Limit (dBuV/m @ 3m)
30 to 88	100	40
88 to 216	150	43.5
216 to 960	200	46.0
Above 960	500	54.0

¹ The restricted bands are detailed in FCC 15.203, RSS 210 Table 1 and RSS 310 Table 2

OUTPUT POWER LIMITS – DIGITAL TRANSMISSION SYSTEMS

The table below shows the limits for output power and output power density. Where the signal bandwidth is less than 20 MHz the maximum output power is reduced to the power spectral density limit plus 10 times the log of the bandwidth (in MHz).

Operating Frequency (MHz)	Output Power	Power Spectral Density
902 – 928	1 Watt (30 dBm)	8 dBm/3kHz
2400 – 2483.5	1 Watt (30 dBm)	8 dBm/3kHz
5725 – 5850	1 Watt (30 dBm)	8 dBm/3kHz

The maximum permitted output power is reduced by 1dB for every dB the antenna gain exceeds 6dBi. Fixed point-to-point applications using the 5725 – 5850 MHz band are not subject to this restriction.

TRANSMIT MODE SPURIOUS RADIATED EMISSIONS LIMITS – FHSS and DTS SYSTEMS

The limits for unwanted (spurious) emissions from the transmitter falling in the restricted bands are those specified in the general limits sections of FCC Part 15 and RSS 210. All other unwanted (spurious) emissions shall be at least 20dB below the level of the highest in-band signal level (30dB if the power is measured using the sample detector/power averaging method).

SAMPLE CALCULATIONS - CONDUCTED EMISSIONS

Receiver readings are compared directly to the conducted emissions specification limit (decibel form) as follows:

$$R_r - S = M$$

where:

R_r = Receiver Reading in dBuV

S = Specification Limit in dBuV

M = Margin to Specification in +/- dB

SAMPLE CALCULATIONS - RADIATED EMISSIONS

Receiver readings are compared directly to the specification limit (decibel form). The receiver internally corrects for cable loss, preamplifier gain, and antenna factor. The calculations are in the reverse direction of the actual signal flow, thus cable loss is added and the amplifier gain is subtracted. The Antenna Factor converts the voltage at the antenna coaxial connector to the field strength at the antenna elements.

A distance factor, when used for electric field measurements above 30MHz, is calculated by using the following formula:

$$F_d = 20 * \text{LOG}_{10} (D_m/D_s)$$

where:

F_d = Distance Factor in dB

D_m = Measurement Distance in meters

D_s = Specification Distance in meters

For electric field measurements below 30MHz the extrapolation factor is either determined by making measurements at multiple distances or a theoretical value is calculated using the formula:

$$F_d = 40 * \text{LOG}_{10} (D_m/D_s)$$

Measurement Distance is the distance at which the measurements were taken and Specification Distance is the distance at which the specification limits are based. The antenna factor converts the voltage at the antenna coaxial connector to the field strength at the antenna elements.

The margin of a given emission peak relative to the limit is calculated as follows:

$$R_c = R_r + F_d$$

and

$$M = R_c - L_s$$

where:

$$R_r = \text{Receiver Reading in dBuV/m}$$

$$F_d = \text{Distance Factor in dB}$$

$$R_c = \text{Corrected Reading in dBuV/m}$$

$$L_s = \text{Specification Limit in dBuV/m}$$

$$M = \text{Margin in dB Relative to Spec}$$

SAMPLE CALCULATIONS - FIELD STRENGTH TO EIRP CONVERSION

Where the radiated electric field strength is expressed in terms of the equivalent isotropic radiated power (eirp), or where a field strength measurement of output power is made in lieu of a direct measurement, the following formula is used to convert between eirp and field strength at a distance of 3m from the equipment under test:

$$E = \frac{1000000 \sqrt{30 P}}{3} \text{ microvolts per meter}$$

where P is the eirp (Watts)

EXHIBIT 1: Test Equipment Calibration Data

1 Page

Radiated Emissions, Band-Edge Measurements, 18-Oct-06**Engineer: Conrad Chu**

<u>Manufacturer</u>	<u>Description</u>	<u>Model #</u>	<u>Asset #</u>	<u>Cal Due</u>
EMCO	Antenna, Horn, 1-18GHz	3115	868	26-Apr-08
Rohde & Schwarz	Power Meter, Dual Channel	NRVD	1539	19-Apr-07
Rohde & Schwarz	Power Sensor 100 uW - 10 Watts	NRV-Z53	1555	28-Oct-06
Rohde & Schwarz	Attenuator, 20 dB , 50 • , 10W, DC-18 GHz	20dB, 10W, Type N	1556	28-Oct-06
Rohde & Schwarz	EMI Test Receiver, 20 Hz-7 GHz	ESIB7	1630	28-Dec-06

RE, 1-18 GHz, 25-Oct-06**Engineer: Conrad Chu**

<u>Manufacturer</u>	<u>Description</u>	<u>Model #</u>	<u>Asset #</u>	<u>Cal Due</u>
Hewlett Packard	Microwave Preamplifier, 1-26.5GHz	8449B	870	13-Jan-07
EMCO	Antenna, Horn, 1-18 GHz (SA40, 30 Hz)	3115	1142	07-Jun-08
Hewlett Packard	SpecAn 30 Hz -40 GHz, SV (SA40) Red	8564E (84125C)	1148	19-May-07
Micro-Tronics	Band Reject Filter, 5470-5725 MHz	BRC50704-02	1681	14-Dec-06

Radio Antenna Port (Power and Spurious Emissions), 30-Oct-06**Engineer: Juan Martinez**

<u>Manufacturer</u>	<u>Description</u>	<u>Model #</u>	<u>Asset #</u>	<u>Cal Due</u>
Hewlett Packard	SpecAn 9 kHz - 40 GHz, Purple (SA40)	8564E (84125C)	1771	04-Nov-06

Radiated Emissions, 30 - 12,750 MHz, 27-Nov-06**Engineer: Mehran Birgani**

<u>Manufacturer</u>	<u>Description</u>	<u>Model #</u>	<u>Asset #</u>	<u>Cal Due</u>
Elliott Laboratories	Log Periodic Antenna 300-1000 MHz	EL300.1000	55	28-Dec-06
Hewlett Packard	EMC Spectrum Analyzer, 9 KHz - 22 GHz	8593EM	1319	17-Apr-07
EMCO	Antenna, Horn, 1-18 GHz (SA40)	3115	1386	11-Jul-08
EMCO	Biconical Antenna, 30-300 MHz	3110B	1498	03-Mar-07
Hewlett Packard	Microwave Preamplifier, 1-26.5GHz	8449B	1780	15-Nov-07
Hewlett Packard	Preamplifier	8447D OPT 010	1826	02-May-07

Radio Antenna Port (Power and Spurious Emissions), 30-Nov-06**Engineer: David Bare**

<u>Manufacturer</u>	<u>Description</u>	<u>Model #</u>	<u>Asset #</u>	<u>Cal Due</u>
Hewlett Packard	EMC Spectrum Analyzer, 9 kHz - 6.5 GHz	8595EM	780	05-Sep-07
Hewlett Packard	SpecAn 9 kHz - 40 GHz, FMT (SA40) Blue	8564E (84125C)	1393	04-Dec-06
Tektronix	1 GHz Oscilloscope	TDS5104	1435	10-Apr-07
Rohde & Schwarz	Power Meter, Dual Channel	NRVD	1787	31-Jan-07
Rohde & Schwarz	Power Sensor, 1 nW-20 mW, 10 MHz-18 GHz, 50ohms	NRV-Z1	1798	17-Apr-07
Agilent	Vector Signal Generator (250kHz - 20GHz)	E8267C	1877	23-Nov-07

Radiated Emissions, 30 - 1,000 MHz, 04-Dec-06**Engineer: Mehran Birgani**

<u>Manufacturer</u>	<u>Description</u>	<u>Model #</u>	<u>Asset #</u>	<u>Cal Due</u>
Elliott Laboratories	Log Periodic Antenna 300-1000 MHz	EL300.1000	297	31-Jan-07
Rohde & Schwarz	Test Receiver, 9 kHz-2750 MHz	ESCS 30	1337	25-Jul-07
EMCO	Biconical Antenna, 30-300 MHz	3110B	1497	26-Jun-07

EXHIBIT 2: Test Measurement Data

18 Pages



EMC Test Data

Client:	Meshdynamics	Job Number:	J64662
Model:	MD2 and MD5	T-Log Number:	T65034
		Account Manager:	Sheareen Washington
Contact:	Francis Da Costa		
Emissions Spec:	EN55022, FCC, 15.247, 15.407	Class:	Radio / A
Immunity Spec:	EN301-489-1; EN301-489-17	Environment:	-

EMC Test Data

For The

Meshdynamics

Model

MD2 and MD5

Date of Last Test: 3/26/2007



EMC Test Data

Client:	Meshdynamics	Job Number:	J64662
Model:	MD2 and MD5	T-Log Number:	T65034
		Account Manager:	Sheareen Washington
Contact:	Francis Da Costa		
Emissions Spec:	EN55022, FCC, 15.247, 15.407	Class:	Radio / A
Immunity Spec:	EN301-489-1; EN301-489-17	Environment:	-

EUT INFORMATION

General Description

The EUT is a Mesh Router which is designed to wirelessly route client data into the network. Normally, the EUT would be placed on a table top during operation. The EUT was, therefore, treated as table-top equipment during testing to simulate the end-user environment. The electrical rating of the EUT is 120/240 V, 50/60 Hz, 7.5 Amps.

Equipment Under Test

Manufacturer	Model	Description	Serial Number	FCC ID
Meshdynamics	MD4350-AA-G	Mesh Router	14456	-
Meshdynamics	MD2	2.4GHz module	-	UZU-MD2
Meshdynamics	MD5	5Ghz module	-	UZU-MD5

Other EUT Details

None

EUT Antenna

The EUT antenna has one 8dBi antenna for both 2.4 and 5Ghz.

The external antenna will be professionally installed.

The antennas connect to the EUT via a standard N Female, thereby professional installation will be required.

EUT Enclosure

The EUT enclosure is primarily constructed of fabricated sheet steel. It measures approximately 20cm wide by 15cm cm deep by 5 cm high.

Modification History

Mod. #	Test	Date	Modification
1	ESD	1/5/2006	Wrapped and attached to the enclosure of EUT the copper tape around the Ethernet connector to pass ESD test.
2			

Modifications applied are assumed to be used on subsequent tests unless otherwise stated as a further modification.



EMC Test Data

Client:	Meshdynamics	Job Number:	J64662
Model:	MD2 and MD5	T-Log Number:	T65034
Contact:	Francis Da Costa	Account Manager:	Sheareen Washington
Emissions Spec:	EN55022, FCC, 15.247, 15.407	Class:	Radio / A
Immunity Spec:	EN301-489-1; EN301-489-17	Environment:	-

Test Configuration #1

Local Support Equipment

Manufacturer	Model	Description	Serial Number	FCC ID
Meshdynamics	MD4350-AA-G	Mesh Router	14446	DoC
	POE - 12i	Injector of Power over Ethernet	181	DoC
Airlink	AR504	4 port Switch Router	3EE04B01314	DoC
Dell	C840	PC Laptop	3J578 AJ1	DoC
Sony	PCG-883L	PC Laptop	n/a	DoC

Remote Support Equipment

Manufacturer	Model	Description	Serial Number	FCC ID
None	-	-	-	-

Interface Cabling and Ports

Port	Connected To	Cable(s)		
		Description	Shielded or Unshielded	Length(m)
POE	Injector	Cat. 5 Ethernet	unshielded cat 5	10

Note: The Bridge port were not connected as the manufacturer stated that these are for peripheral devices purpose and therefore would not normally be connected.

Note: 1 No Ethernet connection on the Injector of Power over Ethernet makes it Repeater mode.

EUT Operation During Emissions Tests



EMC Test Data

Client:	Meshdynamics	Job Number:	J64662
Model:	MD2 and MD5	T-Log Number:	T65034
		Account Manager:	Sheareen Washington
Contact:	Francis Da Costa		
Emissions Spec:	EN55022, FCC, 15.247, 15.407	Class:	Radio / A
Immunity Spec:	EN301-489-1; EN301-489-17	Environment:	-

EUT Operation During Immunity Tests

The EUT was transmitting two frequencies one at 5.26GHz and one at 2.412GHz and receiving one frequency at 5.32GHz. The transmitting frequencies were monitored by pinging the EUT thru laptop PC software. The receiving frequency was monitored by a spectrum analyzer at 5.32GHz for any receiving emissions that might occur.

Performance Criteria for Immunity Tests

Criterion A:

During and after the test the apparatus shall continue to operate as intended. No degradation or loss of function is allowed below a permissible performance level specified by the manufacturer when the apparatus is used as intended. In some cases this permissible performance level may be replaced by a permissible loss of performance. During the test the EUT shall not unintentionally transmit or change its actual operating state and stored data.



EMC Test Data

Client: Meshdynamics	Job Number: J64662
Model: MD2 and MD5	T-Log Number: T65034
	Account Manager: Sheareen Washington
Contact: Francis Da Costa	
Spec: EN55022, FCC, 15.247, 15.407	Class: N/A

FCC 15.247 DTS - Power, Bandwidth and Spurious Emissions

Test Specifics

Objective: The objective of this test session is to perform final qualification testing of the EUT with respect to the specification listed above.

Date of Test: 10/27/2006	Config. Used: 2
Test Engineer: Mehran Birgani	Config Change: None
Test Location: SVOATS #1	EUT Voltage: 120V/60Hz

General Test Configuration

The EUT and all local support equipment were located on the turntable for radiated spurious emissions testing.

For radiated emissions testing the measurement antenna was located 3 meters from the EUT.

When measuring the conducted emissions from the EUT's antenna port, the antenna port of the EUT was connected to the spectrum analyzer or power meter via a suitable attenuator to prevent overloading the measurement system. All measurements are corrected to allow for the external attenuators used.

Ambient Conditions:	Temperature:	19 °C
	Rel. Humidity:	41 %

Summary of Results

Run #	Test Performed	Limit	Pass / Fail	Result / Margin
1	RE, 30 - 40,000 MHz Spurious Emissions In Restricted Bands	FCC Part 15.209 / 15.247(c)	Pass	52.0dBµV/m (398.1µV/m) @ 11568.7MHz (-2.0dB)
2	6dB Bandwidth	15.247(a)	Pass	16.5 MHz
3	Output Power	15.247(b)	Pass	19.25 dBm
4	Power Spectral Density (PSD)	15.247(d)	Pass	-2.4dBm/3kHz

Modifications Made During Testing:

No modifications were made to the EUT during testing

Deviations From The Standard

No deviations were made from the requirements of the standard.



EMC Test Data

Client:	Meshdynamics	Job Number:	J64662
Model:	MD2 and MD5	T-Log Number:	T65034
Contact:	Francis Da Costa	Account Manager:	Sheareen Washington
Spec:	EN55022, FCC, 15.247, 15.407	Class:	N/A

Run #1a: Radiated Spurious Emissions, 30 - 40,000 MHz. Low Channel @ 5745 MHz
Power Level = 19.7 dBm (Average Power)

Other Spurious Emissions

Frequency	Level	Pol	15.209 / 15.247		Detector	Azimuth	Height	Comments
MHz	dB μ V/m	V/H	Limit	Margin	Pk/QP/Avg	degrees	meters	
11490.33	49.2	V	54.0	-4.8	AVG	121	1.0	
11490.80	47.2	H	54.0	-6.8	AVG	39	1.1	
11490.33	62.7	V	74.0	-11.3	PK	121	1.0	
11490.80	60.6	H	74.0	-13.4	PK	39	1.1	
17233.30	63.6	V	90.0	-26.4	PK	57	1.0	
17233.50	61.9	H	90.0	-28.1	PK	105	1.0	
17233.30	51.0	V	80.0	-29.0	AVG	57	1.0	
17233.50	48.7	H	80.0	-31.3	AVG	105	1.0	

Note 1: For emissions in restricted bands, the limit of 15.209 was used. For all other emissions, the limit was set 20dB below the level of the fundamental.

Run #1b: Radiated Spurious Emissions, 30 - 40,000 MHz. Center Channel @ 5785 MHz
Power Level = 19.7 dBm (Average Power)

Frequency	Level	Pol	15.209 / 15.247		Detector	Azimuth	Height	Comments
MHz	dB μ V/m	V/H	Limit	Margin	Pk/QP/Avg	degrees	meters	
11568.67	52.0	V	54.0	-2.0	AVG	113	1.1	
11568.67	67.2	V	74.0	-6.8	PK	113	1.1	
11570.93	47.0	H	54.0	-7.0	AVG	111	1.2	
11570.93	61.5	H	74.0	-12.5	PK	111	1.2	
17356.30	67.6	V	90.0	-22.4	PK	46	1.0	
17357.00	65.9	H	90.0	-24.1	PK	109	1.0	
17356.30	53.7	V	80.0	-26.3	AVG	46	1.0	
17357.00	52.7	H	80.0	-27.3	AVG	109	1.0	

Note 1: For emissions in restricted bands, the limit of 15.209 was used. For all other emissions, the limit was set 20dB below the level of the fundamental.



EMC Test Data

Client:	Meshdynamics	Job Number:	J64662
Model:	MD2 and MD5	T-Log Number:	T65034
Contact:	Francis Da Costa	Account Manager:	Sheareen Washington
Spec:	EN55022, FCC, 15.247, 15.407	Class:	N/A

Run #1c: Radiated Spurious Emissions, 30 - 40,000 MHz. High Channel @ 5825 MHz
Power Level = 19.7 dBm (Average Power)

Other Spurious Emissions

Frequency	Level	Pol	15.209 / 15.247		Detector	Azimuth	Height	Comments
MHz	dB μ V/m	V/H	Limit	Margin	Pk/QP/Avg	degrees	meters	
11649.23	45.3	V	54.0	-8.7	AVG	92	1.0	
11651.23	42.4	H	54.0	-11.6	AVG	41	1.2	
11649.23	58.9	V	74.0	-15.1	PK	92	1.0	
11651.23	55.7	H	74.0	-18.3	PK	41	1.2	
17473.40	69.3	V	90.0	-20.7	PK	38	1.0	
17476.70	68.3	H	90.0	-21.7	PK	23	1.0	
17473.40	54.8	V	80.0	-25.2	AVG	38	1.0	
17476.70	52.9	H	80.0	-27.1	AVG	23	1.0	

Note 1: For emissions in restricted bands, the limit of 15.209 was used. For all other emissions, the limit was set 20dB below the level of the fundamental.

Run #1d: Antenna Conducted Spurious Emissions, 30 - 40,000 MHz.

Refer to plots below. Scans made using RBW=VB=100 KHz with the limit line set at 30dB (since UNII power measurement used) below the highest in-band signal level.

Antenna Conducted Spurious Emissions, 30 - 40,000 MHz. Low Channel @ 5745 MHz

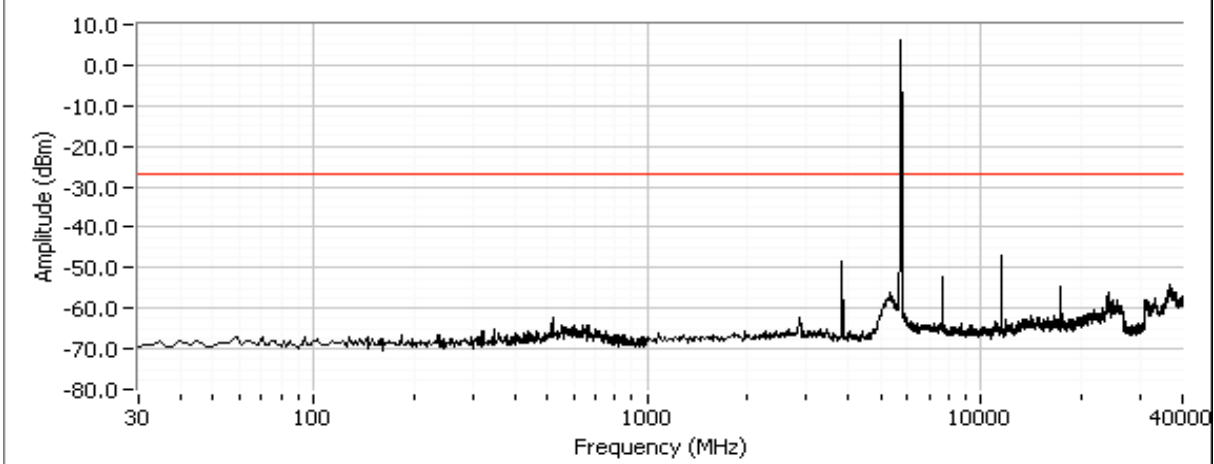

Client: Meshdynamics	Job Number: J64662
Model: MD2 and MD5	T-Log Number: T65034
Contact: Francis Da Costa	Account Manager: Sheareen Washington
Spec: EN55022, FCC, 15.247, 15.407	Class: N/A

Antenna Conducted Spurious Emissions, 30 - 40,000 MHz. Center Channel @ 5785 MHz

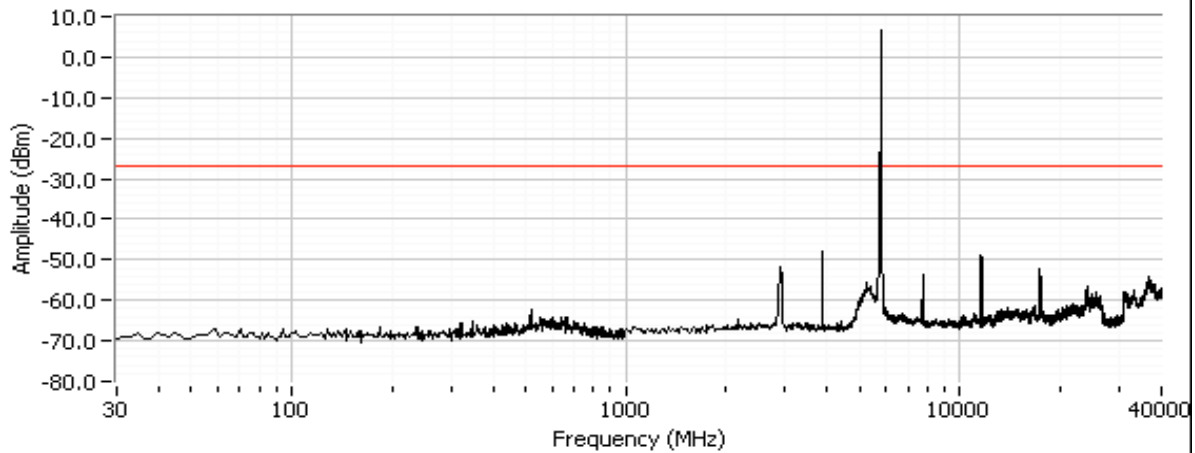

Antenna Conducted Spurious Emissions, 30 - 40,000 MHz. High Channel @ 5825 MHz

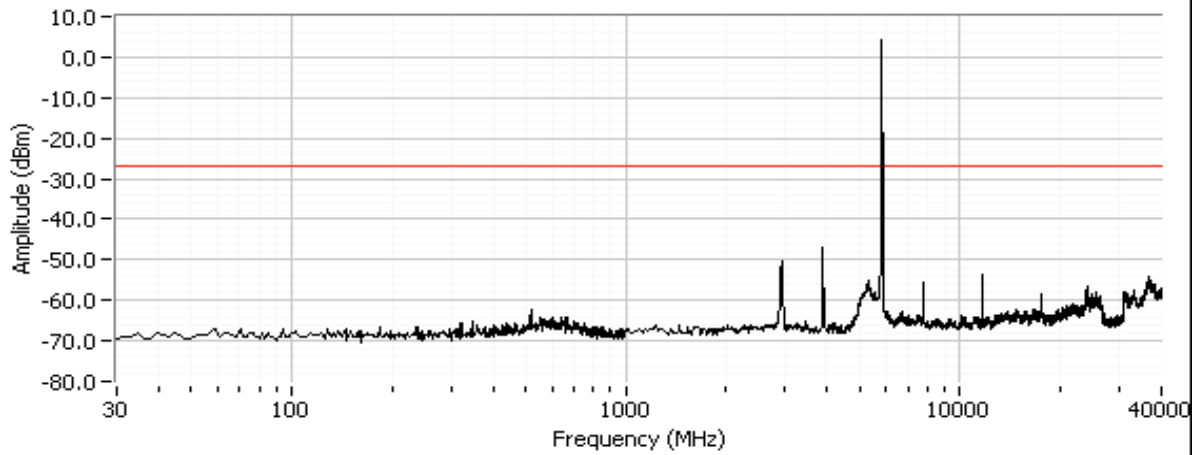

Client: Meshdynamics	Job Number: J64662
Model: MD2 and MD5	T-Log Number: T65034
Contact: Francis Da Costa	Account Manager: Sheareen Washington
Spec: EN55022, FCC, 15.247, 15.407	Class: N/A

If the device operates in the 5725 - 5850 band plots of 5700 - 5780 MHz for the lowest channel and 5820 - 5900 for the highest channel are provided to show that the signal is at least **-30dBc** below 5725 MHz and above 5850 MHz.

ATTEN 30dB ΔMKR 30.83dB
 RL 20.0dBm 10dB/ 13.0MHz

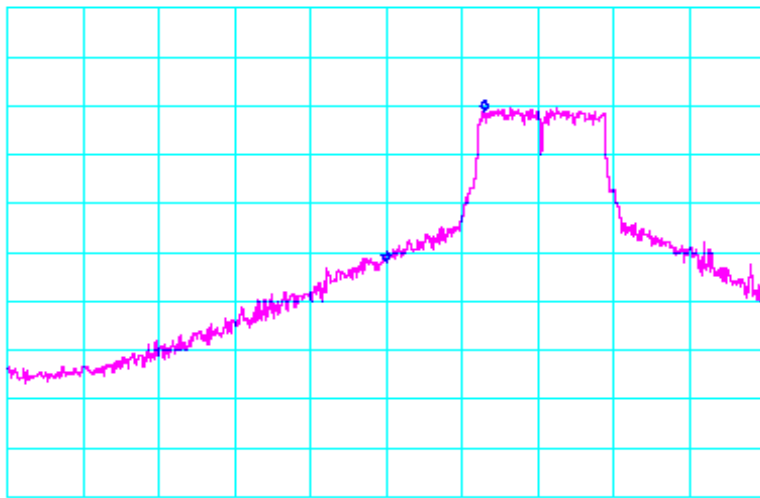

CENTER 5.7250GHz SPAN 100.0MHz
 RBW 100kHz VBW 100kHz SWP 55.0ms

ATTEN 30dB ΔMKR 34.67dB
 RL 20.0dBm 10dB/ -26.7MHz

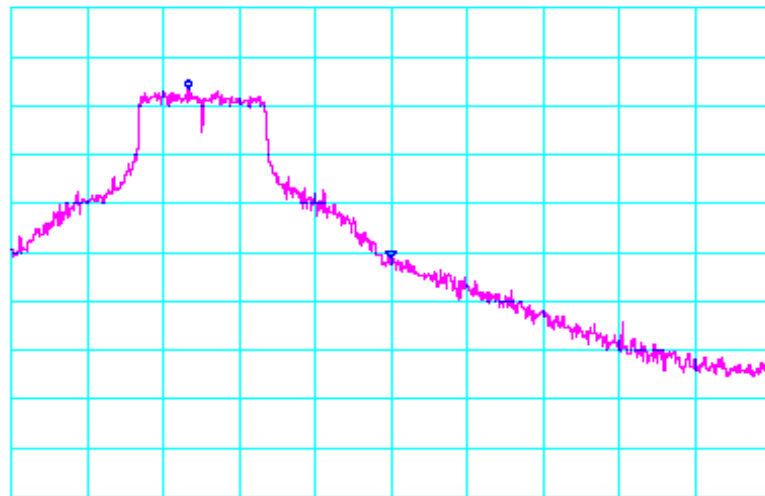

CENTER 5.8500GHz SPAN 100.0MHz
 RBW 100kHz VBW 100kHz SWP 55.0ms

Client: Meshdynamics	Job Number: J64662
Model: MD2 and MD5	T-Log Number: T65034
Contact: Francis Da Costa	Account Manager: Sheareen Washington
Spec: EN55022, FCC, 15.247, 15.407	Class: N/A

Run #2: Signal Bandwidth

Power Setting	Frequency (MHz)	Resolution Bandwidth	6dB Signal Bandwidth	99% Signal Bandwidth
	5745	100kHz	16.5	17.0
	5785	100kHz	16.5	17.1
	5825	100kHz	16.4	17.1

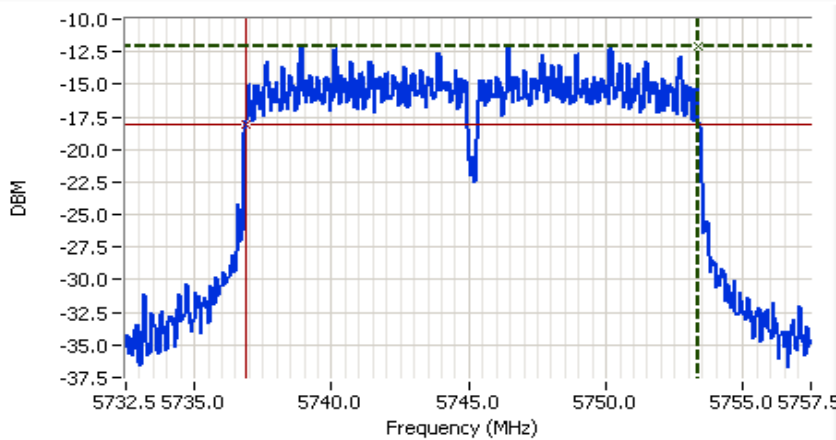

Analyzer Settings
 HP8564E,EMI
 CF: 5745.00 MHz
 SPAN:25.00 MHz
 RB 100 kHz
 VB 100 kHz
 Detector POS
 Att 0
 RL Offset 1.00
 Sweep Time 50.0ms
 Ref Lvl:-9.70DBM

Comments
 5745 MHz
 6dB

Cursor 1	5753.38	-12.12	⊕ ⊖
Cursor 2	5736.86	-18.12	⊕ ⊖

Delta Freq. 16.51
 Delta Amplitude 6.00

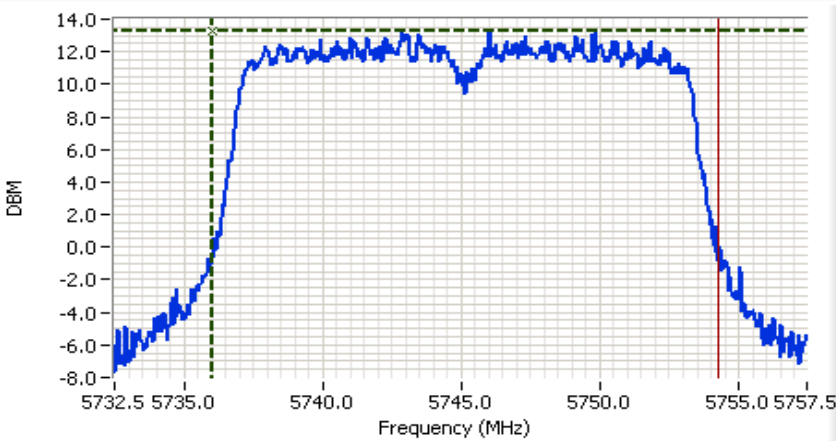

Analyzer Settings
 HP8564E,EMI
 CF: 5745.00 MHz
 SPAN:25.00 MHz
 RB 300 kHz
 VB 1.000 MHz
 Detector POS
 Att 10
 RL Offset 21.00
 Sweep Time 50.0ms
 Ref Lvl:13.10DBM

Comments
 99% BW
 5745 MHz

Cursor 1	5735.99	13.27	⊕ ⊖
Cursor 2	5754.29	-12.73	⊕ ⊖

Delta Freq. 18.30
 Delta Amplitude 26.00





EMC Test Data

Client: Meshdynamics	Job Number: J64662
Model: MD2 and MD5	T-Log Number: T65034
Contact: Francis Da Costa	Account Manager: Sheareen Washington
Spec: EN55022, FCC, 15.247, 15.407	Class: N/A

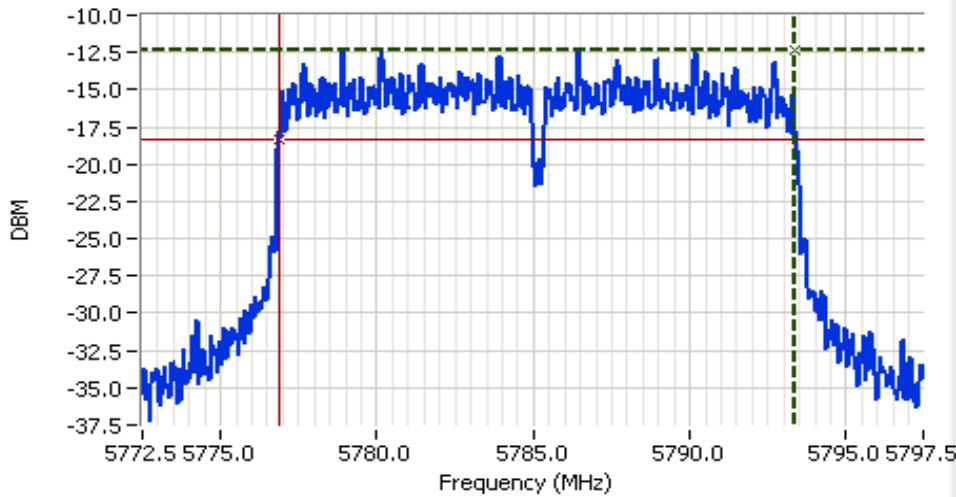

Analyzer Settings
HP8564E,EMI
CF: 5785.00 MHz
SPAN:25.00 MHz
RB 100 kHz
VB 100 kHz
Detector POS
Att 0
RL Offset 1.00
Sweep Time 50.0ms
Ref Lvl:-9.70DBM

Comments
5785 MHz
6dB

Cursor 1	5793.38	-12.28	
Cursor 2	5776.86	-18.28	

Delta Freq. 16.51
Delta Amplitude 6.00

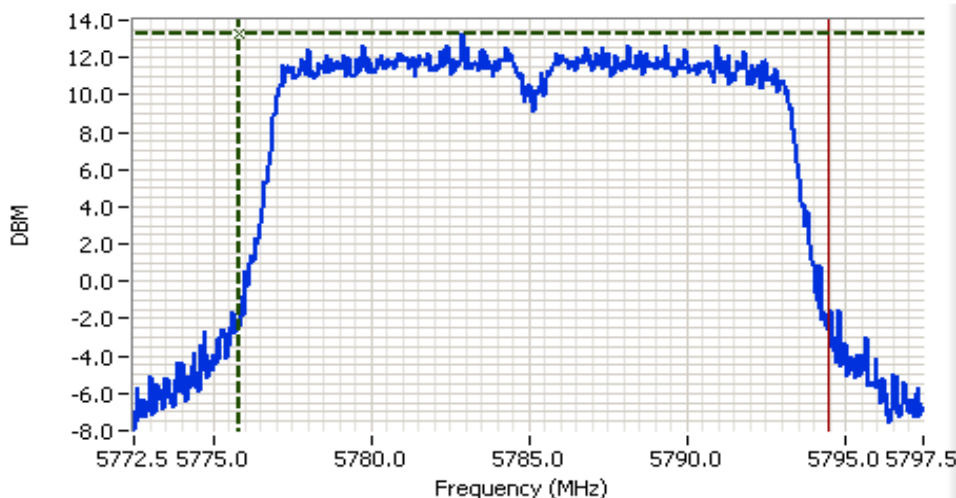

Analyzer Settings
HP8564E,EMI
CF: 5785.00 MHz
SPAN:25.00 MHz
RB 300 kHz
VB 1.000 MHz
Detector POS
Att 10
RL Offset 21.00
Sweep Time 50.0ms
Ref Lvl:13.10DBM

Comments
99% BW
5785 MHz

Cursor 1	5775.84	13.27	
Cursor 2	5794.44	-12.73	

Delta Freq. 18.60
Delta Amplitude 26.00



Client: Meshdynamics	Job Number: J64662
Model: MD2 and MD5	T-Log Number: T65034
Contact: Francis Da Costa	Account Manager: Sheareen Washington
Spec: EN55022, FCC, 15.247, 15.407	Class: N/A

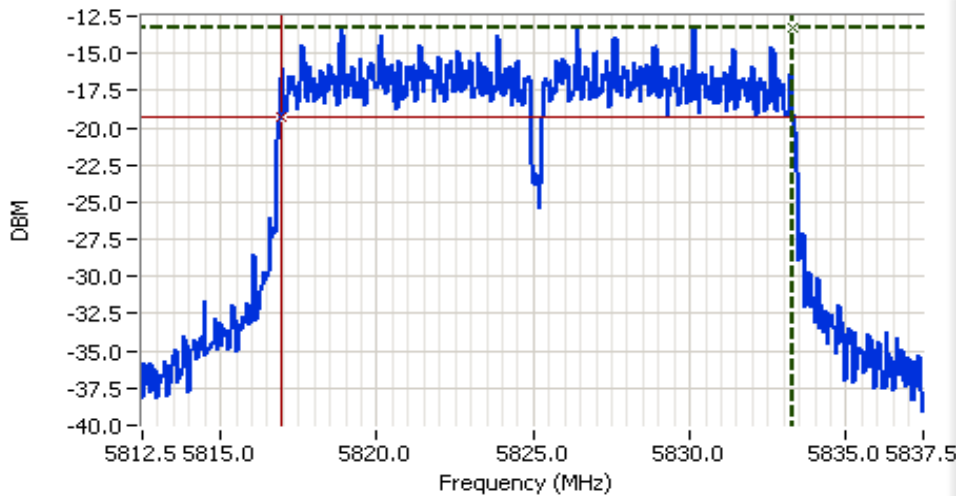

Analyzer Settings
 HP8564E,EMI
 CF: 5825.00 MHz
 SPAN:25.00 MHz
 RB 100 kHz
 VB 100 kHz
 Detector POS
 Att 0
 RL Offset 1.00
 Sweep Time 50.0ms
 Ref Lvl:-9.70DBM

Comments
 5825 MHz
 6dB

Cursor 1	5833.29	-13.28	
Cursor 2	5816.90	-19.28	

Delta Freq. 16.39
 Delta Amplitude 6.00

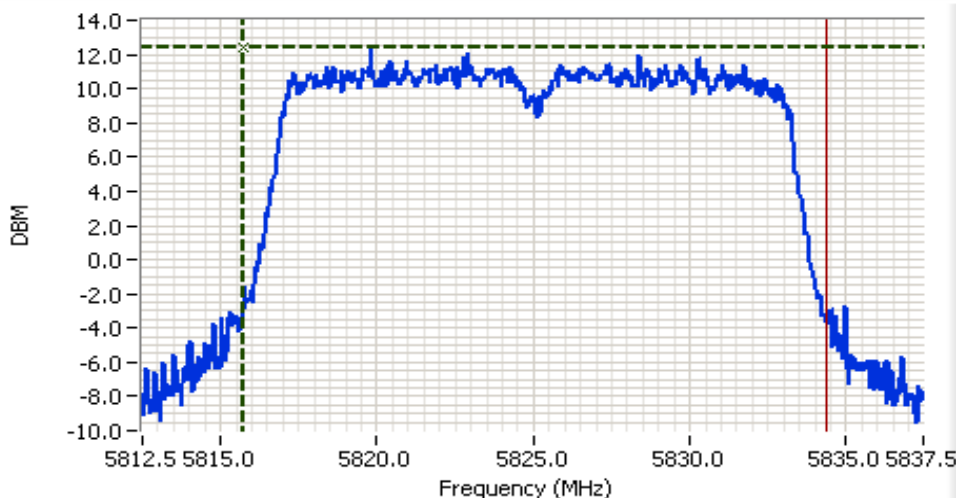

Analyzer Settings
 HP8564E,EMI
 CF: 5825.00 MHz
 SPAN:25.00 MHz
 RB 300 kHz
 VB 1.000 MHz
 Detector POS
 Att 10
 RL Offset 21.00
 Sweep Time 50.0ms
 Ref Lvl:13.10DBM

Comments
 99% BW
 5825 MHz

Cursor 1	5815.76	12.43	
Cursor 2	5834.36	-13.57	

Delta Freq. 18.60
 Delta Amplitude 26.00





EMC Test Data

Client: Meshdynamics	Job Number: J64662
Model: MD2 and MD5	T-Log Number: T65034
Contact: Francis Da Costa	Account Manager: Sheareen Washington
Spec: EN55022, FCC, 15.247, 15.407	Class: N/A

Run #3: Output Power

Maximum antenna gain: 8.0 dBi

Power Setting	Frequency (MHz)	Res BW MHz	Output Power ^{Note 1}		EIRP W	Average Power ^{Note 2}	
			dBm	W		dBm	W
	5745		19.08	0.081	0.511	19.7	0.093
	5785		19.25	0.084	0.531	19.7	0.093
	5825		18.28	0.067	0.425	19.7	0.093

Note 1: Output power measured using a spectrum analyzer (see plots below):
 RBW=1MHz, VB=3 MHz, sample detector, power averaging on (transmitted signal was continuous) and power integration over 100 MHz
 The output power limit is 30dBm

Note 2: Output power measured using an average power sensor - this value is for reference purposes only.

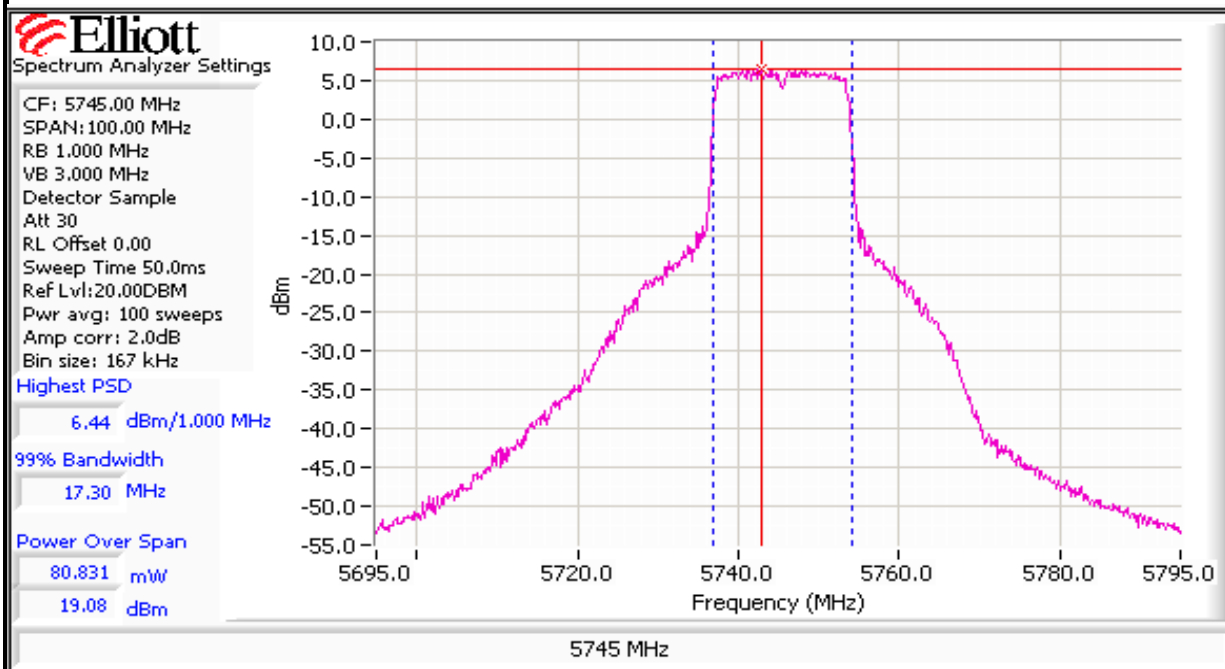

Client: Meshdynamics	Job Number: J64662
Model: MD2 and MD5	T-Log Number: T65034
Contact: Francis Da Costa	Account Manager: Sheareen Washington
Spec: EN55022, FCC, 15.247, 15.407	Class: N/A

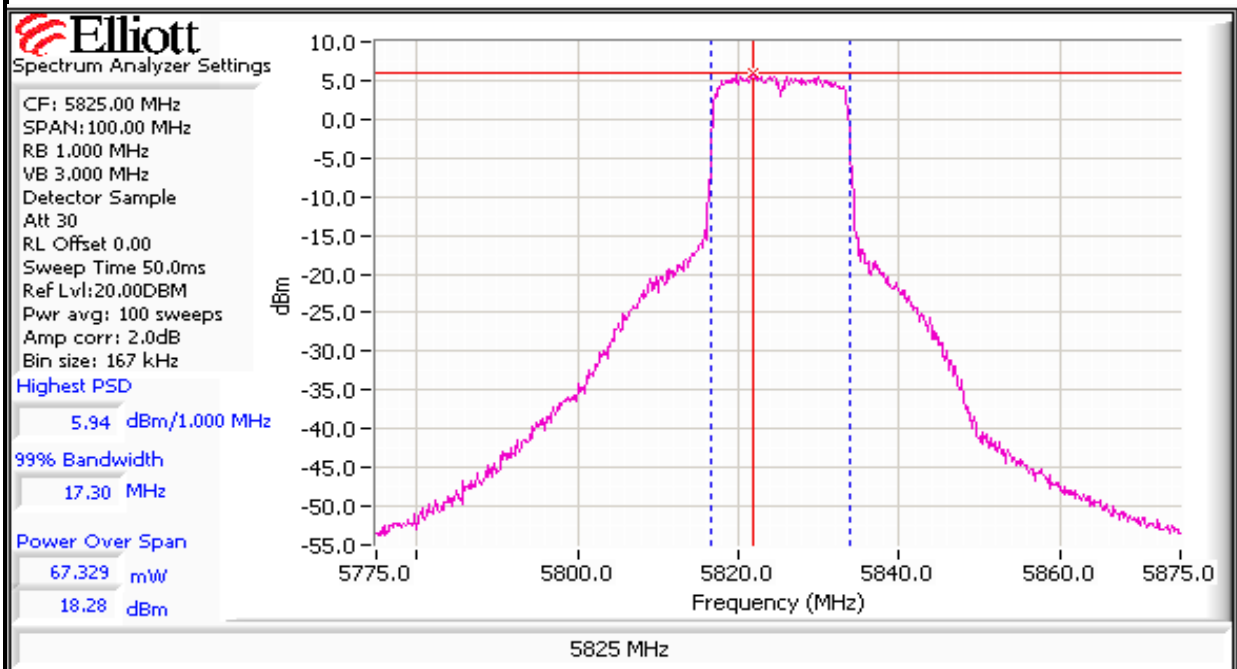
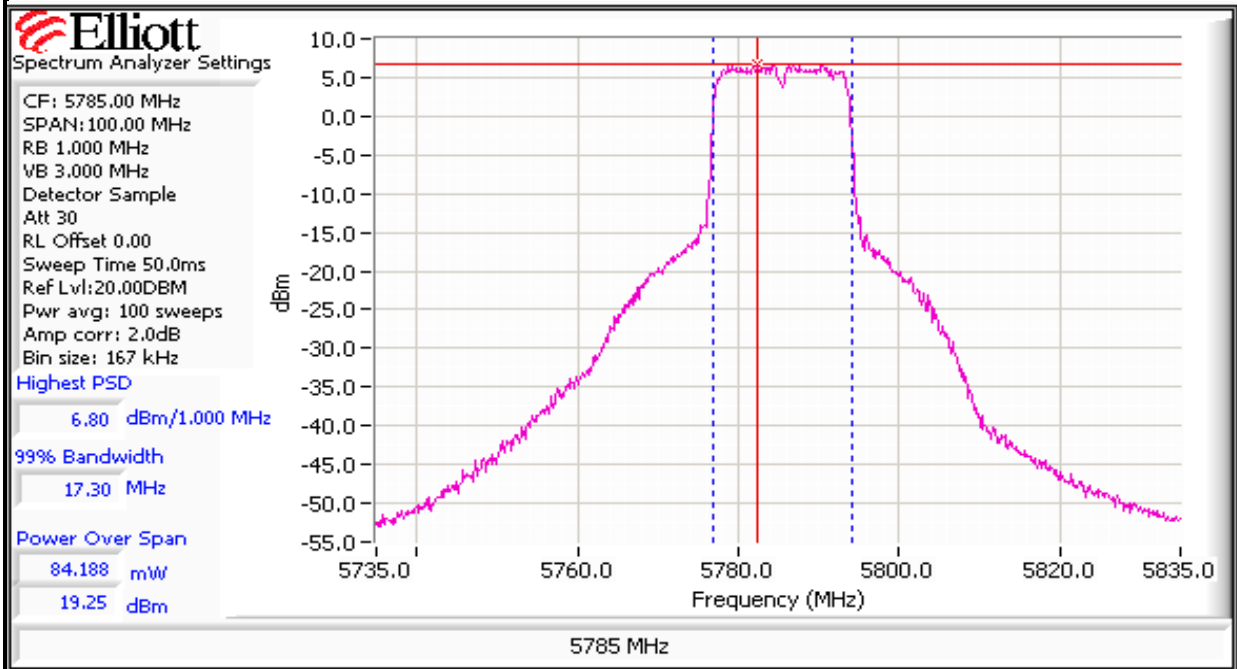



EMC Test Data

Client: Meshdynamics	Job Number: J64662
Model: MD2 and MD5	T-Log Number: T65034
Contact: Francis Da Costa	Account Manager: Sheareen Washington
Spec: EN55022, FCC, 15.247, 15.407	Class: N/A

Run #4: Power Spectral Density

Power Setting	Operating Frequency (MHz)	Freq. @ PPSD	Res BW	P.S.D. (dBm/3kHz)
	5745	5742.57	3kHz	-4.0
	5785	5783.19	3kHz	-2.4
	5825	5825.50	3kHz	-4.9

- Note 1: Freq. @ PPSD: Frequency of the Peak Power Spectral Density (PPSD)
- Note 2: Power spectral density measured using RB=3 kHz, VB=10kHz with a sweep time set to ensure a dwell time of at least 1 second per 3kHz. The measurement is made at the frequency of PPSD determined from preliminary scans using RB=3kHz using multiple sweeps at a faster rate over the 6dB bandwidth of the signal.
- Note 3: Power spectral density calculated from field strength at 3m based on free space path loss formula $E = \sqrt{(30PG) / d}$, where E is the field strength (V/m), PG is the effective isotropic radiated power (W) and d is the distance (3m).

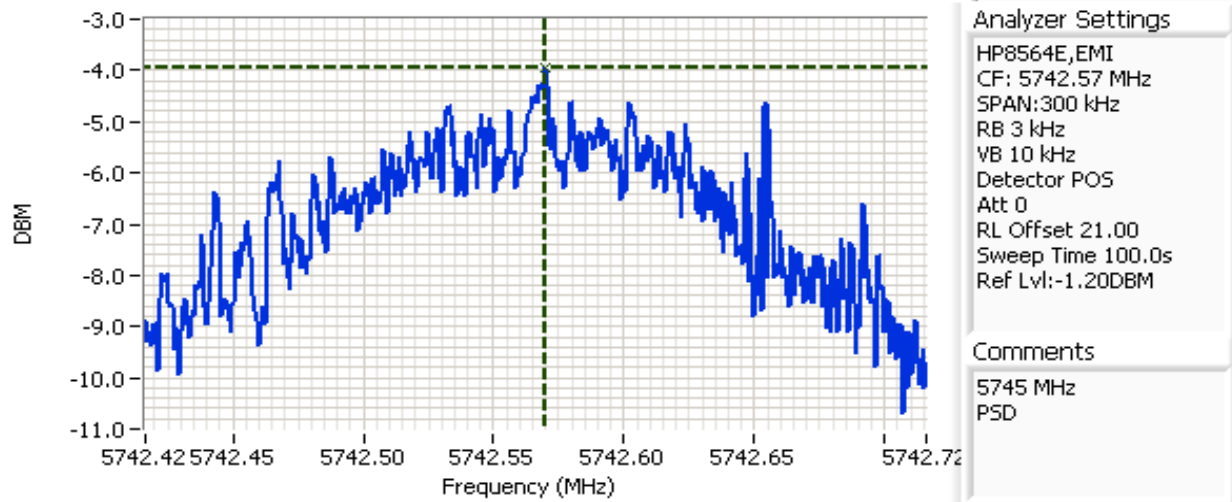

Analyzer Settings
 HP8564E,EMI
 CF: 5742.57 MHz
 SPAN:300 kHz
 RB 3 kHz
 VB 10 kHz
 Detector POS
 Att 0
 RL Offset 21.00
 Sweep Time 100.0s
 Ref Lvl:-1.20DBM

Comments
 5745 MHz
 PSD

Cursor 1 5742.57 -3.95

0.000 0.00





EMC Test Data

Client: Meshdynamics	Job Number: J64662
Model: MD2 and MD5	T-Log Number: T65034
Contact: Francis Da Costa	Account Manager: Sheareen Washington
Spec: EN55022, FCC, 15.247, 15.407	Class: N/A

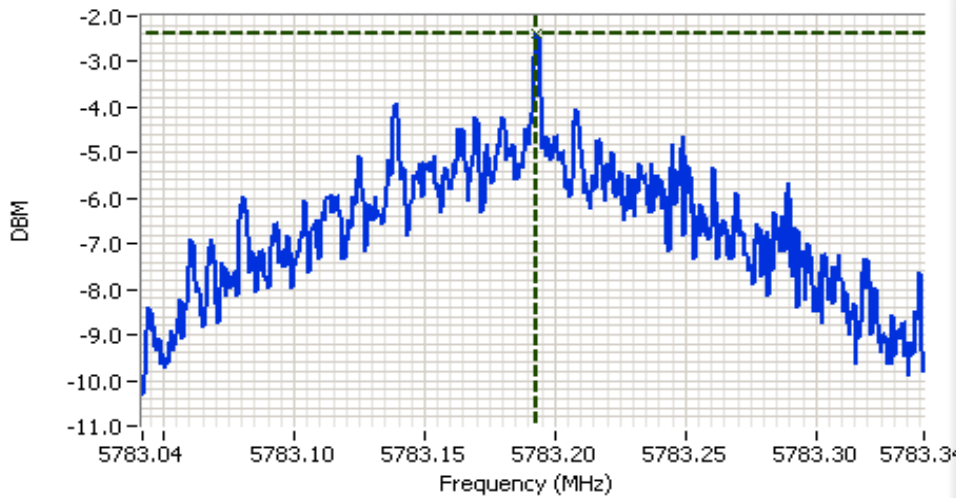

Analyzer Settings
HP8564E,EMI
CF: 5783.19 MHz
SPAN:300 kHz
RB 3 kHz
VB 10 kHz
Detector POS
Att 0
RL Offset 21.00
Sweep Time 100.0s
Ref Lvl:1.10DBM

Comments
5785 MHz
PSD

Cursor 1 5783.19 -2.40
0.000 0.00

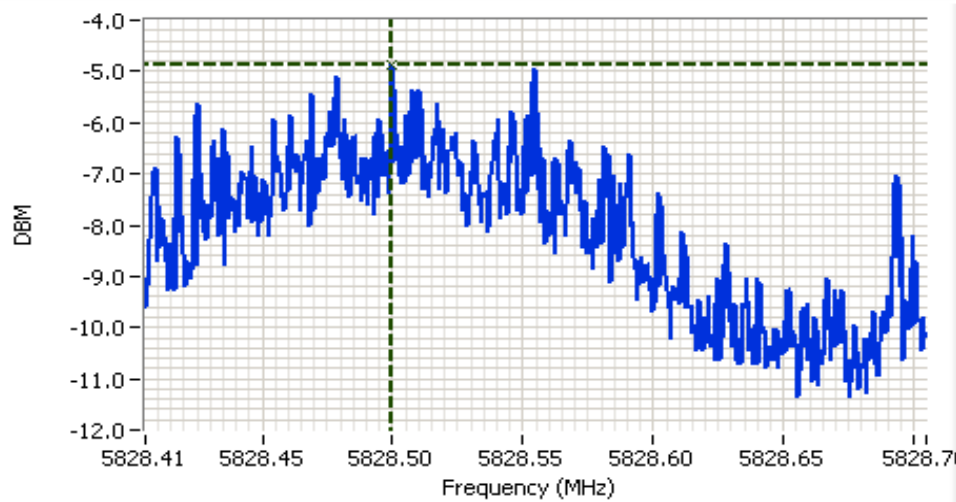

Analyzer Settings
HP8564E,EMI
CF: 5828.56 MHz
SPAN:300 kHz
RB 3 kHz
VB 10 kHz
Detector POS
Att 0
RL Offset 21.00
Sweep Time 100.0s
Ref Lvl:-2.70DBM

Comments
5825 MHz
PSD

Cursor 1 5828.50 -4.87
0.000 0.00



Client:	Meshdynamics	Job Number:	J64662
Model:	MD2 and MD5	T-Log Number:	T65034
		Account Manager:	Sheareen Washington
Contact:	Francis Da Costa		
Standard:	EN55022, FCC, 15.247, 15.407	Class:	Radio / A

Radiated Emissions

Test Specific Details

Objective: The objective of this test session is to perform final qualification testing of the EUT with respect to the specification listed above.

Date of Test: 1/13/2007 9:07	Config. Used: 1
Test Engineer: Juan Martinez	Config Change: None
Test Location: SVOATS #2	EUT Voltage: -48Vdc

General Test Configuration

The EUT and all local support equipment were located on the turntable for radiated emissions testing.

The test distance and extrapolation factor (if applicable) are detailed under each run description.

Note, **preliminary** testing indicates that the emissions were maximized by orientation of the EUT and elevation of the measurement antenna. **Maximized** testing indicated that the emissions were maximized by orientation of the EUT, elevation of the measurement antenna, and manipulation of the EUT's interface cables.

Ambient Conditions:

Temperature:	18 °C
Rel. Humidity:	35 %

Summary of Results

Run #	Test Performed	Limit	Result	Margin
1	RE, 1000 - 10000 MHz, Maximized Emissions	RSS 210	Pass	47.1dBµV/m (225.9µV/m) @ 7053.4MHz (-6.9dB)

Modifications Made During Testing:

No modifications were made to the EUT during testing

Deviations From The Standard

No deviations were made from the requirements of the standard.



EMC Test Data

Client:	Meshdynamics	Job Number:	J64662
Model:	MD2 and MD5	T-Log Number:	T65034
Contact:	Francis Da Costa	Account Manager:	Sheareen Washington
Standard:	EN55022, FCC, 15.247, 15.407	Class:	Radio / A

Run #1: Radiated Spurious Emissions, 1000 - 10000 MHz (Receiver spurious)

All radios receiving continuously on channels 2437 and 5785

Note that all significant emissions below 1GHz were from the digital device (as demonstrated by preliminary scans with the transmitters operating, receivers operating and radios in stand-by) and are covered in a separate test session.

Frequency MHz	Level dB μ V/m	Pol v/h	FCC Class B		Detector Pk/QP/Avg	Azimuth degrees	Height meters	Comments
			Limit	Margin				
7053.367	47.1	V	54.0	-6.9	AVG	300	2.1	
7000.020	45.6	V	54.0	-8.5	AVG	140	1.3	
7053.366	43.8	H	54.0	-10.2	AVG	0	1.0	
2309.998	43.6	H	54.0	-10.4	AVG	300	1.6	
7000.022	43.5	H	54.0	-10.5	AVG	180	1.0	
2309.998	39.5	V	54.0	-14.5	AVG	96	1.3	
7026.689	38.0	H	54.0	-16.0	AVG	40	1.2	
7080.180	36.5	H	54.0	-17.5	AVG	300	1.7	
2501.251	35.5	V	54.0	-18.5	AVG	20	1.3	
2500.095	35.4	H	54.0	-18.6	AVG	350	1.6	
1253.183	33.2	V	54.0	-20.9	AVG	14	1.0	
1249.665	32.6	H	54.0	-21.4	AVG	172	1.0	
7053.367	52.6	V	74.0	-21.4	PK	300	2.1	
7000.020	50.5	V	74.0	-23.5	PK	140	1.3	
7053.366	50.0	H	74.0	-24.1	PK	0	1.0	
7000.022	49.3	H	74.0	-24.7	PK	180	1.0	
2309.998	49.2	H	74.0	-24.8	PK	300	1.6	
7026.689	47.5	H	74.0	-26.5	PK	40	1.2	
2309.998	47.4	V	74.0	-26.6	PK	96	1.3	
2501.251	46.6	V	74.0	-27.4	PK	20	1.3	
7080.180	46.6	H	74.0	-27.4	PK	300	1.7	
1253.183	44.3	V	74.0	-29.7	PK	14	1.0	
2500.095	44.2	H	74.0	-29.8	PK	350	1.6	
1249.665	44.1	H	74.0	-30.0	PK	172	1.0	

EXHIBIT 3: Photographs of Test Configurations

Pages

EXHIBIT 4: Proposed FCC ID Label & Label Location

***EXHIBIT 5: Detailed Photographs
of Meshdynamics Model MD4000 Construction***

Pages

***EXHIBIT 6: Operator's Manual
for Meshdynamics Model MD4000***

Pages

**EXHIBIT 7: Block Diagram
of Meshdynamics Model MD4000**

Pages

**EXHIBIT 8: Schematic Diagrams
for Meshdynamics Model MD4000**

Pages

***EXHIBIT 9: Theory of Operation
for Meshdynamics Model MD4000***

Pages

EXHIBIT 10: RF Exposure Information

Pages